

REVISIONS			
Rev.	Drawn	Date	Revisions

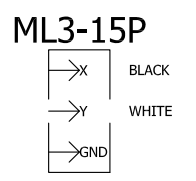

MENCOM CCEM-06  
44mm x 27mm (6B)  
6P 16A MALE

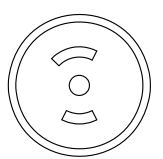
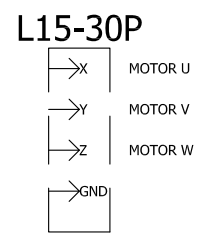
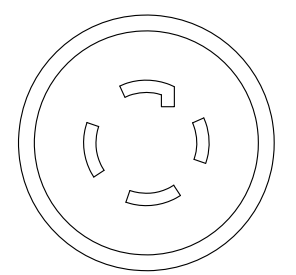
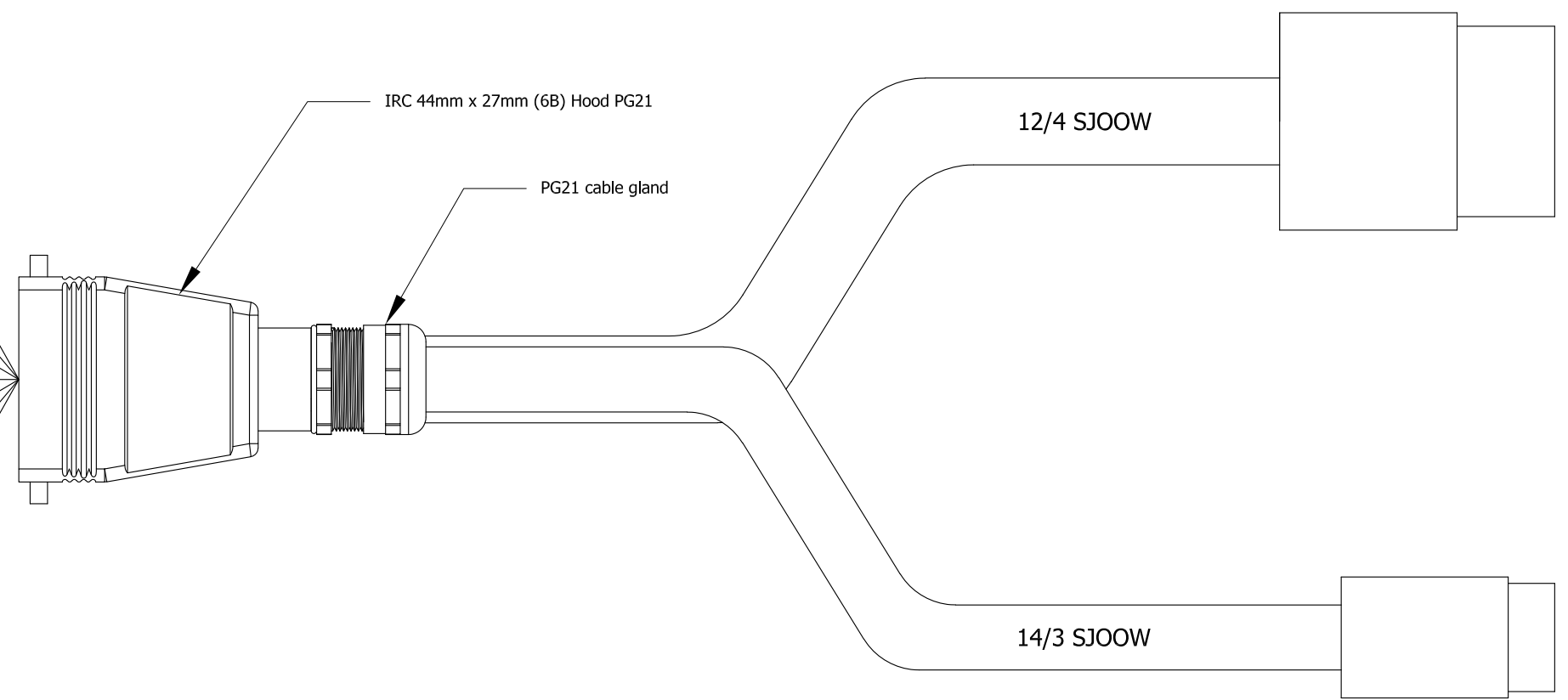
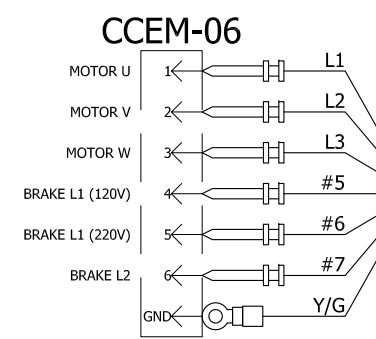
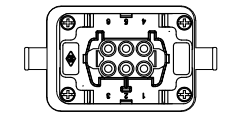

Apprentice Motor/Brake Squid  
Wiring Diagram  
Scale: NTS  
Drawn on: 12/6/18  
Drawn By: mrw

tolerances:  
X : ±1/16"  
.xx : ±0.010  
.xxx : ±0.003

the information contained in the drawing is the property of creative conners inc.